







TR8100V Thermostat Instructions

ver 1.0

LCD symbols

Symbol	Event	Symbol	Event
	The buttons are locked	AUTO	Automatic mode, executes the programmed schedules
	Heating is turned on	Override	Temporary temperature override
	Frost protection activated	Err	The floor sensor is not being read by the thermostat
	Program number		Economy temperature
	Manual mode		Comfort temperature



Configuration Menu

To enter into the setting menu please follow the steps below:

Step 1, Turn the thermostat off by pressing  ;

Step 2, Press  , you will then see menu 01.

Step 3, Use the up and down arrows to adjust the sensor selection which is Menu 01(Air sensing;Air and Floor, or Floor only)

Step 4, Press  to move to the next Menu and once you have all the menu options set,

Setp 5, Press  to accept and store.

Menu #	Feature	Explanation	Adjustment (press up & down buttons to adjust)
01	Mode/Sensor selection	This thermostat is a combination model which allows you to choose 3 different modes. A mode = Air Sensing Only(Has built in sensor) AF mode = Air & Floor sensing(Floor probe must be installed) F mode = Floor Sensing(Floor probe must be installed)	A, AF, F
02	Switching Differential	The number of degrees difference before switching. The default is 1°C which means the thermostat will switch the heating on 0.5°C below the set temperature and will turn it off 0.5°C above the set temperature.With a 2°C differential the heating will switch on 1°C below the set temperature and will switch off 1°C above the set temperature.	1°C, 2°C....10°C (1°C by default)
03	Air Temp Calibration	This is to recalibrate the air temperature if required.	-1°C = decrease 1 °C, 1°C = increase 1°C...
04	Floor Temp Calibration	This is to recalibrate the floor temperature if required.	-1°C = decrease 1 °C, 1°C = increase 1°C...
05	Temperature Readout (AF mode only)	This gives you the option to show the Air Temperature, Floor Temperature or to show both Air & Floor at intervals.	A= to show air temperature, F=to show floor temperature, A--F = to show both in 5 second intervals
06	Maximum Floor Temp (AF mode only)	This is to protect the floor surface.	20°C~ 40°C (40°C by default)
07	Temperature Format	This allows the temperautre to be set to show °C or °F.	°C or °F
08	Clock Format	You can select the clock to show in either 12 or 24 hour time	24 (default), 12- hour or 24-hour clock format
09	Frost Protection	This is to avoid your room temperature going below 5°C	on= activated, off= deactivated
10	5+2 / 7 Day Mode	This allows you to program either 5 days at once, then the 2 days of the weekend separately, or a full 7 days at the same time or 7 days separately	01 = 5+2 day programmable 02 = 7 day programmable

Setting the clock and day of the week

This thermostat is fitted with a real time clock. It is essential that the clock time and day are set accurately if you require your programmed events to start on time. To set follow the steps below:

1) Touch the time display and the time will start flashing. Use the up and down arrows to set the time.By holding the arrow down the time will change faster.

2) Press  to move to the Day setting and use the up and down arrows to get to the correct day.

3) Press  to store and exit.

Setting the Program Schedules

This thermostat has the ability to program each individual day of the week separately, or program 7 days of the week at once. You can also program weekdays (5 days) to one schedule and then weekends (2 days) to a different schedule. See the Menu information for details on how to set this up.(refer to Menu 10)

Program	Start Time	Setpoint	Explanation
1	WAKE 07:00	22 °C	Set to the time you would like to wake to and the temperature you want during the morning, until you left for the day.
2	LEAVE 09:30	16 °C	Set to the time you leave home and the temperature you wish your home to maintain while you are away at work perhaps.
3	RETURN 16:30	22 °C	Set to the time you return home at end of the day and the temperature you want during evening until bed time.
4	SLEEP 22:30	16 °C	Set to the time you sleep and the temperature you want overnight(usually a comfortable and energy saving temperature).

Above are default program schedules, to make changes, follow easy steps as below.

- Press **SCHEDULE** and the day display will start flashing. (If your thermostat is set to 5+2 day programmable mode, the programming will skip to step3)
- Use **▽** to adjust the day of the week you want to start programming or to the day you wish to edit an existing event / program.
(Press **ALL DAYS** to select all 7 days of the week, and to cancel press **ALL DAYS** again.)
- Press **NEXT** the LCD screen will show Program 1() and the time will be flashing.
- Use **△** and **▽** to adjust the time you wish the Program 1 event to commence for the selected day/days.
- Press **NEXT** and the temperature will start flashing.
- Use **△** and **▽** to set the desired temperature to be maintained during Program 1.
- Press **NEXT** and the LCD screen will show Program 2 with the time display flashing, this signifies that the second daily event is now ready to be programmed.

Repeat steps 4,5,6 to set the remaining programs/events, then press **DONE** to store and exit.

Hint: During setting programs, press **DELETE** will clear a program entry and thermostat will maintain the temperature setpoint of the last executed program until the beginning of the next program.

Auto / Manual Mode

Press **MODE** to select Auto/Manual mode. In Manual mode(), the thermostat maintains a constant set temperature manually set by the user. In Auto mode, the thermostat executes the preprogrammed schedules.

Holiday Function

The Holiday function reduces the temperature in your room to the frost protection temperature. The thermostat will maintain this temperature for the duration of the holiday and will then automatically return to the program mode on your return.

Press **HOLIDAY**, enter the duration of your holiday by **△** or **▽**.
Press **DONE**. To cancel a Holiday, reduce the holiday period to 00 days.

Lock the Keypad

To lock the keypad, press and hold the top left corner of display for 5 seconds, you will see a lock symbol . To unlock, repeat the steps above and the lock symbol will disappear.

Reset to Factory Setting

With thermostat turned off, press and hold OFF for 5 seconds until you can see -- : -- on LCD.

Temporary Temperature Override

Touch the temperature display, and it will start to flash. Use up or down buttons to adjust. Press **DONE** to accept, and you will see "Override" above the temperature display. Thermostat will maintain the new set temperature until the next programmed event(comfort level). To cancel the override setting, press **RUN SCHEDULE**

Installation and Wiring

Carefully separate the front half of the thermostat from the back plate by placing a small flat head terminal driver into the slots on the bottom face of the thermostat.

Carefully unplug the ribbon connector which is plugged in to the front half of the thermostat. Place the thermostat front half somewhere safe. Wire the thermostat as shown in the diagrams below.

Screw the thermostat back plate on to the flush box

Re-connect the thermostat ribbon cable and clip the two halves together.

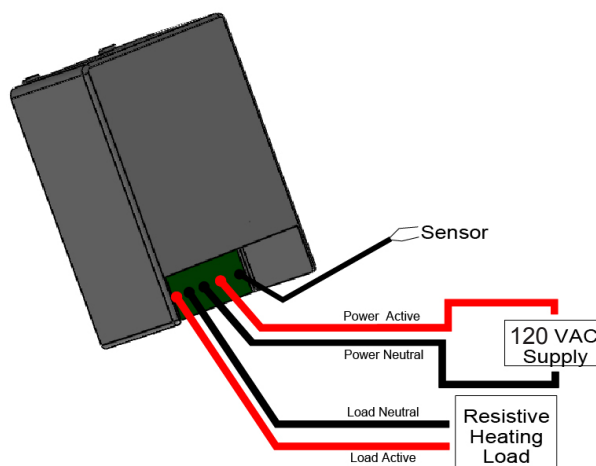

This product should be installed by a qualified electrician.